

REVISED PER ECNT		3/10/99	M.HIGGY
REVISED PER DCR# T-22658		3/10/99	M.HIGGY

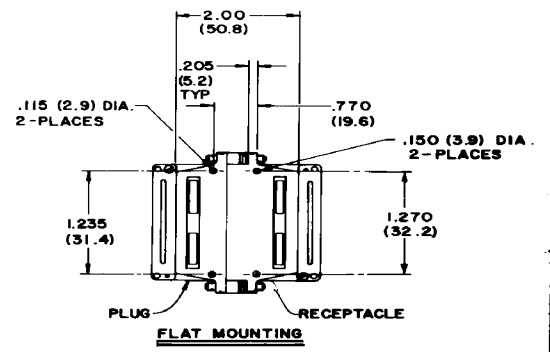
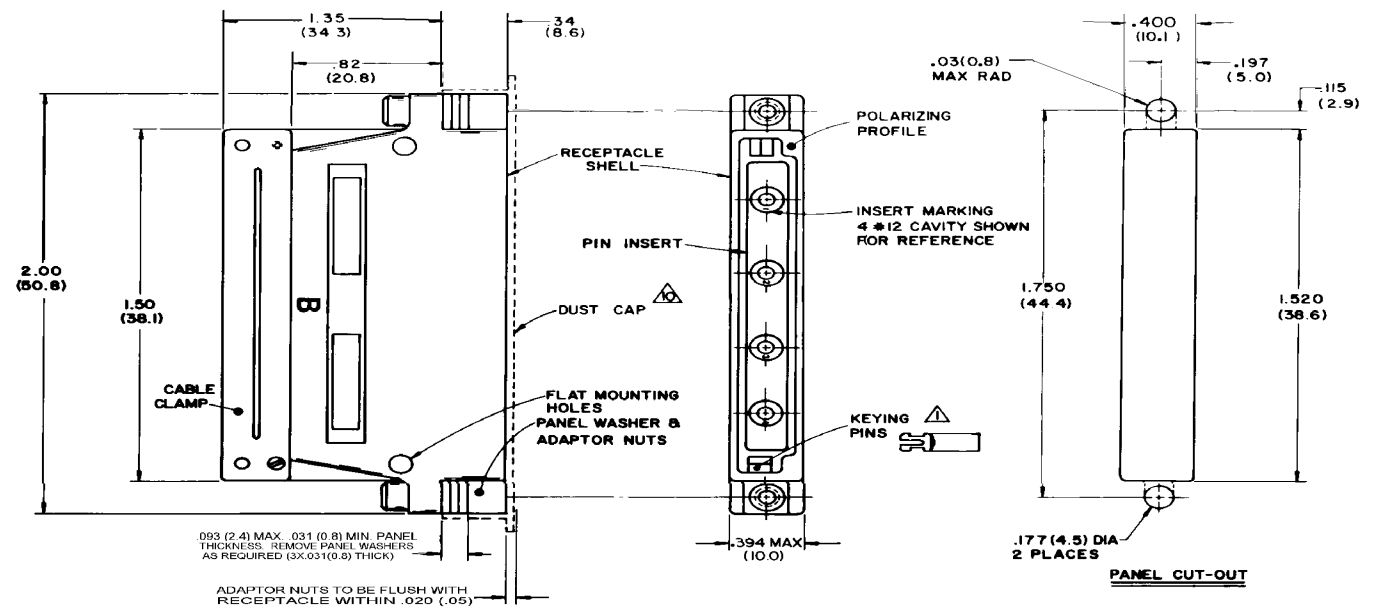

.093 (2.4) MAX. .031 (0.8) MIN. PANEL THICKNESS. REMOVE PANEL WASHERS AS REQUIRED (3X.031(0.8) THICK)

ADAPTOR NUTS TO BE FLUSH WITH RECEPTACLE WITHIN .020 (.05)

NOTES:

- 1. KEYING CODE DOES NOT FORM A PART OF RAYCHEM PART NUMBER SYSTEM AND SHOULD BE OMITTED WHEN ORDERING. KEYING PINS SUPPLIED UNINSTALLED. SEE TABLE II FOR KEYING POSITIONS.
- 2. COMPLETE CONNECTORS AND ACCESSORIES ARE INDIVIDUALLY BAGGED AND LABELED.
- 3. CONNECTOR IS ENVIRONMENTALLY SEALED MEETING THE REQUIREMENTS PER CONNECTOR SPECIFICATION D-6015.
- 4. REAR GROMMET INSERT WILL SEAL ON SMOOTH INSULATION FROM .097" TO .158" O.D.
- 5. CONNECTOR DESIGNED FOR USE WITH POWER AND SHIELDED CONTACTS PER TABLE I.
- 6. INSERTS ARE PERMANENTLY INSTALLED, CONTACTS MAY BE INSERTED AND REMOVED USING TOOL PER NOTE 8.
- 7. ALL UNUSED CAVITIES TO BE SEALED USING SEALING PLUG NUMBER M83723-28-12.
- 8. ALL CONTACTS SIZE 12 ARE INSERTED AND REMOVED USING TOOL NUMBER M83723-31-12.
- 9. REFER TO RAYCHEM SPECIFICATION D-6015 FOR COMPLETE DETAILS.
- 10. CONNECTOR SUPPLIED WITH A SHIPPING DUST CAP OVER ENGAGING END.
- 11. PART NUMBER VARIABLE: MTCR-10X-04P

1 = NICKEL PLATE PER MIL-C-26074  
3 = CADMIUM PLATE PER QQ-P-416 OVER NICKEL UNDERPLATE

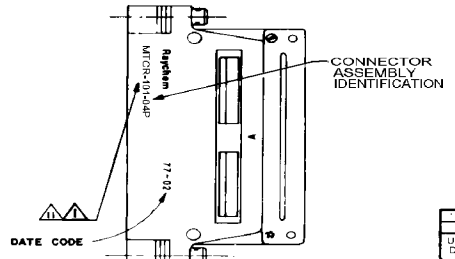









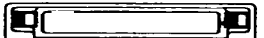
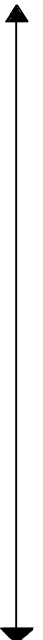

VIEW SHOWING IDENTIFICATION

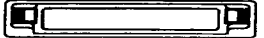
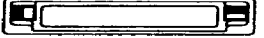
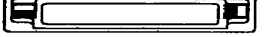
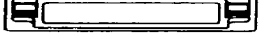
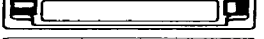
If this document is printed it becomes uncontrolled.  
Check with the web for latest revision.

SPECIFICATION CONTROL DRAWING

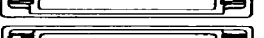
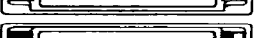
REV	DATE	DESCRIPTION	PART NUMBER	DESCRIPTION
1	12-01-97		CRN	RAYCHEM
2	12-01-97		CRN	RAYCHEM
3	12-01-97		CRN	RAYCHEM
4	12-01-97		CRN	RAYCHEM
5	12-01-97		CRN	RAYCHEM
6	12-01-97		CRN	RAYCHEM
7	12-01-97		CRN	RAYCHEM
8	12-01-97		CRN	RAYCHEM
9	12-01-97		CRN	RAYCHEM
10	12-01-97		CRN	RAYCHEM
11	12-01-97		CRN	RAYCHEM
12	12-01-97		CRN	RAYCHEM
13	12-01-97		CRN	RAYCHEM
14	12-01-97		CRN	RAYCHEM
15	12-01-97		CRN	RAYCHEM
16	12-01-97		CRN	RAYCHEM
17	12-01-97		CRN	RAYCHEM
18	12-01-97		CRN	RAYCHEM
19	12-01-97		CRN	RAYCHEM
20	12-01-97		CRN	RAYCHEM
21	12-01-97		CRN	RAYCHEM
22	12-01-97		CRN	RAYCHEM
23	12-01-97		CRN	RAYCHEM
24	12-01-97		CRN	RAYCHEM
25	12-01-97		CRN	RAYCHEM
26	12-01-97		CRN	RAYCHEM
27	12-01-97		CRN	RAYCHEM
28	12-01-97		CRN	RAYCHEM
29	12-01-97		CRN	RAYCHEM
30	12-01-97		CRN	RAYCHEM
31	12-01-97		CRN	RAYCHEM
32	12-01-97		CRN	RAYCHEM
33	12-01-97		CRN	RAYCHEM
34	12-01-97		CRN	RAYCHEM
35	12-01-97		CRN	RAYCHEM
36	12-01-97		CRN	RAYCHEM
37	12-01-97		CRN	RAYCHEM
38	12-01-97		CRN	RAYCHEM
39	12-01-97		CRN	RAYCHEM
40	12-01-97		CRN	RAYCHEM
41	12-01-97		CRN	RAYCHEM
42	12-01-97		CRN	RAYCHEM
43	12-01-97		CRN	RAYCHEM
44	12-01-97		CRN	RAYCHEM
45	12-01-97		CRN	RAYCHEM
46	12-01-97		CRN	RAYCHEM
47	12-01-97		CRN	RAYCHEM
48	12-01-97		CRN	RAYCHEM
49	12-01-97		CRN	RAYCHEM
50	12-01-97		CRN	RAYCHEM
51	12-01-97		CRN	RAYCHEM
52	12-01-97		CRN	RAYCHEM
53	12-01-97		CRN	RAYCHEM
54	12-01-97		CRN	RAYCHEM
55	12-01-97		CRN	RAYCHEM
56	12-01-97		CRN	RAYCHEM
57	12-01-97		CRN	RAYCHEM
58	12-01-97		CRN	RAYCHEM
59	12-01-97		CRN	RAYCHEM
60	12-01-97		CRN	RAYCHEM
61	12-01-97		CRN	RAYCHEM
62	12-01-97		CRN	RAYCHEM
63	12-01-97		CRN	RAYCHEM
64	12-01-97		CRN	RAYCHEM
65	12-01-97		CRN	RAYCHEM
66	12-01-97		CRN	RAYCHEM
67	12-01-97		CRN	RAYCHEM
68	12-01-97		CRN	RAYCHEM
69	12-01-97		CRN	RAYCHEM
70	12-01-97		CRN	RAYCHEM
71	12-01-97		CRN	RAYCHEM
72	12-01-97		CRN	RAYCHEM
73	12-01-97		CRN	RAYCHEM
74	12-01-97		CRN	RAYCHEM
75	12-01-97		CRN	RAYCHEM
76	12-01-97		CRN	RAYCHEM
77	12-01-97		CRN	RAYCHEM
78	12-01-97		CRN	RAYCHEM
79	12-01-97		CRN	RAYCHEM
80	12-01-97		CRN	RAYCHEM
81	12-01-97		CRN	RAYCHEM
82	12-01-97		CRN	RAYCHEM
83	12-01-97		CRN	RAYCHEM
84	12-01-97		CRN	RAYCHEM
85	12-01-97		CRN	RAYCHEM
86	12-01-97		CRN	RAYCHEM
87	12-01-97		CRN	RAYCHEM
88	12-01-97		CRN	RAYCHEM
89	12-01-97		CRN	RAYCHEM
90	12-01-97		CRN	RAYCHEM
91	12-01-97		CRN	RAYCHEM
92	12-01-97		CRN	RAYCHEM
93	12-01-97		CRN	RAYCHEM
94	12-01-97		CRN	RAYCHEM
95	12-01-97		CRN	RAYCHEM
96	12-01-97		CRN	RAYCHEM
97	12-01-97		CRN	RAYCHEM
98	12-01-97		CRN	RAYCHEM
99	12-01-97		CRN	RAYCHEM
100	12-01-97		CRN	RAYCHEM

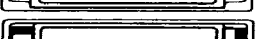
**TABLE II**  
KEYING CODE CHART 

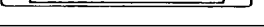
PART NUMBER 	* *	POSITION OF KEYS
MTCR-10X-04P-	AA	
	AB	
	AC	
	AD	
	BA	
	BB	
	BC	
	BD	
	CA	
	CB	
	CC	
	CD	
	DA	
	DB	
	DC	
	DD	
	MTCR-10X-04P-	

**TABLE I**

**PIN CONTACT AND TOOLING INFORMATION**

CONTACT TYPE	MILITARY PART NO.	WIRE STRIP LENGTH	TERMINATION TOOL
SHIELDED CONTACT FOR COAX CABLE D-602-0106 OR D-602-0094	_____	SEE DRAWING D-602-0106 OR D-602-0094	SEE DRAWING D-602-0106 OR D-602-0094
CONTACT FOR TWISTED PAIR D-602-0104	_____	SEE DRAWING D-602-0104	SEE DRAWING D-602-0104
POWER CONTACT SIZE 12	M39029/4-12-12	1/4" TO 5/16"	M22520/1-01 POSITIONER M22520/1-02

If this document is printed it becomes uncontrolled.  
Check with the web for latest revision.

<b>A</b>	CODE IDENT. NO.	DWG. NO.	<b>D</b>
	06090	MTCR-10X-04P	
DO NOT SCALE THIS DRAWING		CAD NAME: 122698B.TIF	SHEET 2 OF 2